

Activity chairs,

The District Rocket Day Guidelines contains important information to help you prepare for a successful rocket day, and can be found <http://www.samhoustonbsa.org/district-operations#activities>.

Rocket Day dates and locations can be found at www.shac.org/rocket-day. A registration form is being set up for each district online and a webpage about rocket day can be found on each district website (under the activities tab).

It is recommended that supplemental activities be set up in addition to the rocket launch. Some parents are driving quite a distance to attend.

Ask each pack to sponsor an activity. Ask packs to bring their booth from Scout Fair.

		Page
Main Activity:	Launching Estes Rockets	
Shooting Sports:	BB Guns	
	Archery	
	Sling Shots	
Games	Obstacle Course	
	Marbles	
	Parachute Games	
	Ultimate	
	Giant Marbles	
Crafts	Kickball	
	Bomb Pops	
	Craft Bead Project	
	Pom Pom Shooters	
Activities	Pump Rockets	
	Bubble Hose	
	Raingutter Regatta	
STEM	Tower Building (spaghetti and marshmallows)	
Bobcat Activities	Scout Law Puzzle (2 versions)	
	Fortune Teller	
	Bobcat Book	
	Bobcat Wheel	
	Bobcat Relay Race Game	

Please share with us any additional great ideas that you have so we can share with the other event chairs. We have started a volunteer packet template for you to edit and customize.

Rocket Day

Volunteer Packet

Date
Location
Address
Time



Volunteers,

Thank you so much for volunteering. Please don't forget why we are doing this. Our goal is to provide new Scouts with an introduction to Scouting.

Arrival: Please check-in at registration at _____ (location /address)

Customer Service: Every volunteer is expected to be friendly and helpful to everyone onsite. This event is the first Scouting experience for many of our participants and we want this to be a positive event. Not everyone is aware of all of BSA and SHAC's policies, so this is our opportunity to gently and kindly inform them of our rules. Obviously, a major safety violation (e.g., pointing a gun in an unsafe manor) would need to be dealt with immediately, but in a friendly way. Any YPT issue needs to be immediately addressed and reported to the district executive.

Bring:

- Field uniform
- Water bottle
- Insect repellent
- Closed toed shoes
- Rain gear
- BSA Health and Medical Record (Parts A & B)
(www.scouting.org/sitecore/content/home/healthandsafety/ahmr.aspx)

Optional:

- Camp chair
- Sunscreen
- Sunglasses
- Hat
- Snacks

Water: Please drink lots of water.



Youth Protection and Safety: All participants must follow [Youth Protection Guidelines](#) at all Scouting events. Highlights include:

- Two-deep leadership on all outings required.
- One-on-one contact between adults and youth members is prohibited.
- The buddy system should be used at all times.
- Discipline must be constructive.
- BSA [Guide to Safe Scouting](#) policies must be followed.

Volunteer Assignments: Following is a brief description of areas where help is needed. All instructions and supplies will be provided on site. Also, please make sure your replacement shows up before you leave your assigned area. Shift times cross over to ensure coverage and so volunteers can share helpful hints and lessons learned.

Shift	Type of help needed
Time ???	Registration: check-in, answer basic questions
Time ???	Set Up: get equipment to program areas, set up tables, put up shooting sports ranges (e.g., fencing), put up signage (staff to provide signs), set up canopies, set up parking cones to direct traffic
Time ???	Parking Attendants: direct parking
Time ???	Facilities: refill water stations, check bathrooms, empty trash cans
Time ???	Program: run and assist activities (see details below)
Time ???	Clean up

Program: Describe how the event will work, schedule, rotates, etc.

More Information: For more information, visit www.____shac.org/rocket-day.

Also, join our district Facebook page at www.facebook.com/??? and our council Facebook page at www.facebook.com/shac.bsa



Contact: <insert>

Rocket Launch

Extra Rockets

Scouts may bring extra rockets (e.g., for a sibling who is a returning Scout). The rocket must be a skill level 0 to 2 and the engine must be an A or B class engine.

Packs may purchase additional rockets for returning Scouts in bulk from Brad McClain (brad@paulssupplies.com) or the local [Scout Shop](#). Allow two weeks for delivery.

Individuals may purchase additional rockets and motor engines at the local [Scout Shop](#) or [Hobby Lobby](#).

If Scouts bring their own rocket(s), the rocket should be built prior to arrival at the launch site and they must provide their own appropriate class A or B rocket engine. Remember that only adults are allowed to handle the engines.

Ensure that you review the rocket kit instructions and select the recommended engine size.

Watch this video for a very good briefing on prepping rockets prior to launch: <https://youtu.be/hC6evC1N05c>.

Rocket Launch Safety

The safety of our youth, volunteers, staff, and employees is an important part of the Scouting experience.

Only adults are allowed to handle or load rocket motors. Adults should always closely supervise ALL rocketry building, launching, and recovery activities.

[National Association of Rocketry \(NAR\) Safety Code](#) and other safety guidelines will be followed:

- Launch safety – countdowns, 15-foot safety circle
- Launchers – End of launch rod must be above eye level.
- Launch site – 200-foot open area required for a type B engine; monitor wind and dry grass conditions
- Every rocket should be safety inspected prior to launch.
- If a rocket misfires or does not launch, be sure to wait a minimum of 30 seconds before approaching it.
- Lightning, winds, or any adverse weather should immediately stop the launch.
- Recovery safety – Do not attempt recovery from power lines, tall trees, etc.
- In case of inclement weather, the launch will be rescheduled.

BSA [Guide to Safe Scouting](#) policies must be followed.

Shooting Sports

The ranges are run by certified range masters. The range master will provide on-site instruction to volunteers.

The range masters will need assistance with lining up the Scouts waiting for their turn and watching for safety issues.

Please let all Scouts and siblings (as appropriate) have at least one turn. If time allows, they can have more than one turn.



Note: For wrist rockets (slingshots), BSA requires that every shooter must have an adult with them.

Games: Obstacle Course

Need more



STEM: Tower Building

1. Snap the spaghetti into smaller pieces.
2. Push the ends of the spaghetti into the marshmallows to build different shapes for your tower. Encourage Scouts to try different shapes.

Materials:

- spaghetti (uncooked)
- marshmallows
- optional: paper, objects
- sample project

Hint: The Science Bit

- Cubes tend to make stable structures, especially if they have diagonal pieces to strengthen the sides.
- The more the marshmallow can grip the spaghetti, the stronger the joint. If there is a heavy load on a marshmallow, it may change shape until the joint fails so be careful!
- Use shorter pieces of spaghetti or put in braces to strengthen squares and rectangles.
- If you don't use pieces of equal length on each side, your tower may start to twist and topple.
- There will be most strain on the base of the tower – think about how you can add strength to the base.
- Optional: Start with a cube and add weight and see if the structure starts to lean or break (see example on the right). Ask Scouts to figure out what can be done to make it stronger? Does adding diagonal pieces help?

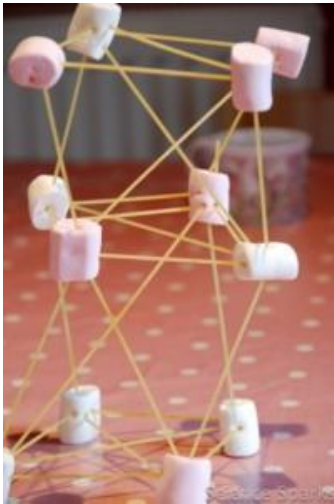

Craft: Amazing Flying Machine (Bomb Pops)



Materials:

- 5 tongue depressors per Scout
- several samples

1. Give each Scout 5 tongue depressors
2. Show Scouts how to weave the 5 sticks together as shown.
3. Demonstrate how to safely throw the flying machine like a Frisbee
4. Let the Scouts fly them and watch the machine “explode” on contact with the ground or other surfaces.
5. Let Scouts assemble it again, and have more fun.

Scouts will need parent help!

Activity: Pump Rockets



Materials:

- PVC pipe to use as mold, several
- Construction paper, few pieces per Scout
- Tape to seal top
- Masking tape
- Scissors to cut fins, several
- Decorations (e.g., stickers, markers, fins)
- Sample project

1. Show Scouts a sample rocket and give instructions
2. Scouts should wrap a piece of construction paper around the pipe tight, but not so tight you cannot get it to slide off.
3. Tape the paper at three spots. Wrap the tape around the paper rocket so it laps over itself.
4. Allow Scouts to decorate their rocket with markers or stickers
5. Remove paper rocket from the pipe. Turn in the pipe to get your foam. Do not keep the pipe.
6. Place a piece of foam at the top of the rocket with some of it sticking out of the top. Use lots of tape and seal the entire top so the foam stays in place and air will not escape. The foam adds an element of weighting, so how it's installed, doesn't really matter other than there has to be an air-tight seal.
7. Cut a couple of fins and add to the bottom of the rocket: any number, size, shape... whatever the Scout wants. The fins aren't really integral for flight, more for aesthetics. You don't need a whole piece of construction paper to make one fin, you can use scraps

Notes:

- Precut the fins for #5 (about 3 inches long and 1/2' wide)
- Let the Scouts take turn launching their rockets as many times as they want.



Craft: Slithering Snake Beads (find a different pony bead project)

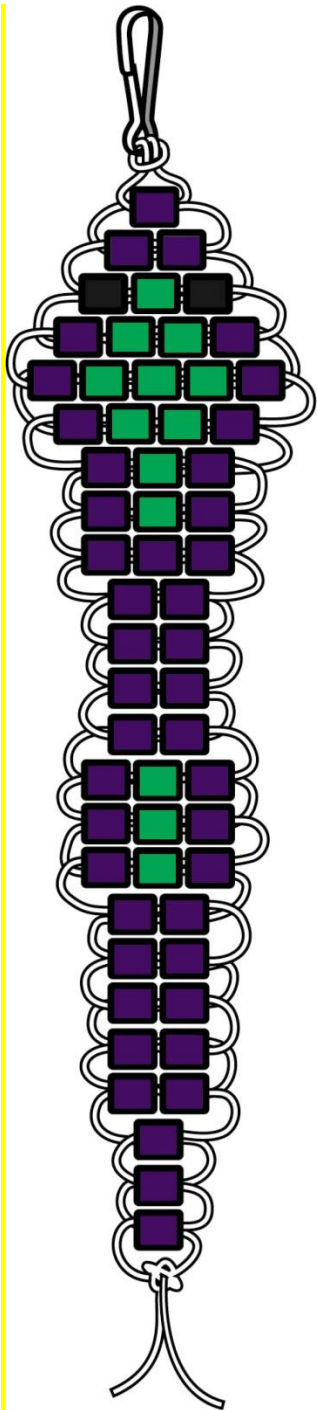

Instructions:

1. Fold cord in half to find the center.
2. Create a small loop at the center.
3. Thread this loop of cord into the lanyard hook (Figure A).
4. Pull the ends through the loop to form a knot on the hook. (Figure B)
5. Tape the hook to the table to hold in place while beading.

Materials:

- 1 hook
- 2 yards of string
- 13 green beads
- 43 purple beads
- 2 black beads
- Tape
- Sample project

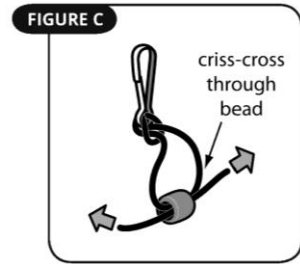
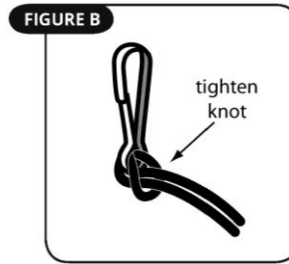
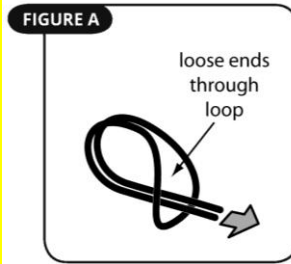

6. Starting at the top (near the hook), thread one purple bead onto the cord and insert the other end of the cord into the same bead from the opposite direction. (Figure C).
7. Row 2 of the beading uses 2 purple beads. Thread one end of the cord through the beads. Then thread the other end through those same 2 beads, from the opposite directions. Helpful Hint: thread both cords into the beads before pulling the beads tight up to the previous row.
8. Follow the chart for the rest of the rows.
9. At the end of the tail, knot the 2 cords together to hold in place. Trim any excess cord.

Pattern:

Row 1.....	1 purple
Row 2.....	2 purple
Row 3.....	1 black, 1 green, 1 black
Row 4	1 purple, 2 green
Row 5	1 purple, 3 green
Row 6	1 purple, 2 green
Row 7-8	1 purple, 1 green,
Row 9.....	1 purple
Row 10-13	3 purple
Row 14-16	2 purple
	1 purple, 1 green,
Row 17-21	1 purple
Row 22-24	2 purple
	1 purple

Notes:

- Encourage parents to help.
- The first few rows are the most difficult
- All materials and instructions (seen on the left) will be in a ziplock bag.
- Extra materials are available if items are missing from the bags.
- Only give one bag per Scout.
- There is a sample available to show the Scouts.
- This activity takes about 45 minutes.
- Encourage Scouts to take incomplete project with them to finish later to keep group on schedule.



Bubble Hose



Materials:

- empty plastic bottle with bottom cut off, one per Scout
- piece of terry cloth fabric or old washcloth cut in circles, or use old tube socks, one per Scout
- rubber band, one per Scout
- dish detergent
- water
- bowls or aluminum pan
- paper towels
- marker
- plastic bag (e.g. grocery bag) so Scout can take it home and not get other items in their bag wet, one per Scout

Write name on water bottle.

Put the fabric over the open bottom of bottle and secure with a rubber band.

Put some dish detergent in a bowl and add a little bit of water.

Dipping into the soap mixture, gently blow into the mouth of your bottle. A slow, gentle stream of air will create a long chain of bubbles. Instruct the kids not to inhale, or you might get a mouthful of bubbles ~ yuck!

This activity is very fun and works great. Scouts can use it over and over.



Parachute Games



Materials:



- parachute
- beach ball
- colored balls
- cotton balls

- **Popcorn:** Place a number of beanbags, small balls, or cotton balls onto the parachute. Shake to make them pop up like "popcorn."
- **Ball Roll:** Have the children try to roll the balls into the hole in the middle of the parachute. (Or have children try to keep the balls from going into the hole in the center.)
- **Merry-Go-Round:** Children turn their bodies sideways and hold the chute with one hand. They then walk around in a circle, making a "Merry-Go-Round." For variety, children can hop, skip, jump, etc. You can stop music as a cue to reverse and go the other direction.
- **Poison Snakes:** Place three or four jump ropes onto the chute. Shake the parachute to keep the snakes from "biting" (touching) you.
- **Parachute Tag:** Lift the parachute high into the air. Call out two children's names. They must trade empty spots by running under the chute, before it comes down on them.
- **Mushroom:** Standing, lift the parachute waist height. Count to three - with "one" and "two" being small practice lifts. On three, all lift the chute overhead, and crouch down pulling the parachute edges down as well. This creates what looks like a "mushroom."
- **The Wave:** Children put their hands up, one after another, in order – creating a synchronized "wave" like in the stands at a baseball game.
- **See-Saw Pull:** From a sitting position, have children pull the parachute back and forth in a cooperative see-saw motion.
- **Bouncing Balls:** Have one or two children under the chute trying to hit the balls as they touch the surface, knocking them off the parachute (from underneath.)
- **Flying Saucer:** All take one step forward upon lifting the chute in the air. Upon command, all let go, and watch as it slowly floats.
- **Ball in the Bucket:** Break into two or more "teams." Each team will have a different colored ball (or balls.) They will try to keep their color ball from going into the middle circle, while trying to get the other teams' color of ball(s) into the hole.
- **Turtle:** The parachute becomes a giant turtle shell with everyone underneath it on hands and knees. Everyone must cooperate and work together to get the turtle to move about.
- **Beach Ball Fun:** Use a beach ball, moving it with waves, around on the parachute.
- **Parachute Volleyball:** Split into two sides of the parachute. One side tries to knock the ball off of the other side (half of chute), right past the other "team."
- **The Canopy:** Squat down with parachute flat on the ground. On the count of three, stand up and stretch arms above head, creating a canopy.
- **Parachute Tag:** Lift the parachute high overhead. Call one child's name and have her run (skip, hop, twirl or crawl) to the other side before the parachute comes down and tags her.

Raingutter Regatta



Materials:

- 2 raingutter regattas, painted and ready to sail
- Straws (cut in half), one per boy
- Printed copies of sail (made on cardstock), see appendix
- Scissors
- Hole Punch
- Raingutters and saw horses or Raingutter Regatta Inflatable Raceway, Item #612687 from Scout Shop
- 2-six foot' tables (one for raingutter and one for Scouts to make their sail )
- Water
- Hose or bucket 
- Crayons or markers
- Copies of sail pattern
- Towels or mop to clean up water spills, optional if

Option: Sails can be precut and have the two holes punched at the top and bottom.

Scouts color the paper sail, cut it out, and use a hole punch to put the hole in the top and bottom.

Allow Scouts to either just blow their boat down the raingutter or race another Scout.



Raingutter Regatta Inflatable Raceway, Item 612687

Pom Pom Shooters

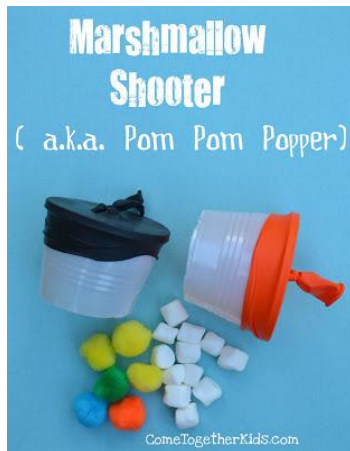

Materials:

- Plastic cups (9 oz) – 2 per Scout, toilet paper tube, or empty yogurt containers
- Balloons (12')
- Pom poms or mini marshmallows
- Firing line and targets to shoot towards (e.g., paper plates on the ground or hung up that have numbers on them (e.g., 100 for 100 points))
- Scissors

1. Cut the bottom part off of your plastic cup. I found it worked best to double up the (2) cups and I cut off the bottom third.
2. Tie a knot at the end of your balloon and cut off about 1/2" from the other end.



3. Now stretch the balloon over the end of the cup. It's best to put the balloon on the top part of the cup where the lip is, otherwise the cup bends too much when putting on the balloon. Sturdier cups may only require one cup.
4. Put the marshmallow or pom pom inside the cup on the knotted center, then aim the cup away from you, pull back on the outer knot and launch away! Make sure the Scouts are not shooting at targets and not each other. Note: Marshmallows go farther than the pom poms



Game: Giant Marbles



Materials:

- Length of rope or sidewalk chalk (if playing on concrete)
- Balls of different sizes (basketballs, soccer balls, beach balls)

Just like in regular marbles, the object of the game is to knock the balls out of the circle by hitting them with another ball, your “shooter.”

Make a large circle by drawing it with chalk or laying it out with the rope. Pick one of the heavier balls to be your shooter, and place the rest of balls inside the circle.

Standing at a specified distance from the circle, each boy takes a turn rolling the shooter toward the other balls. If he knocks a ball out of the circle while keeping the shooter inside the circle, the boy gets another turn.

If you have a small group of boys playing, each boy can keep the balls they knock out of the circle. The game is over when all of the balls have been knocked out.

With a larger group, simply have the boys keep track of the number of balls they knock out. Put them back in the circle to continue playing. You can end the game after a specific amount of time or when a boy reaches a certain score.

If you have a very large pack, consider setting up multiple game rings. Divide the boys into smaller groups, each with their own ring. You could even have the winners from each group play against each other for a championship!

STEM: Strawplane

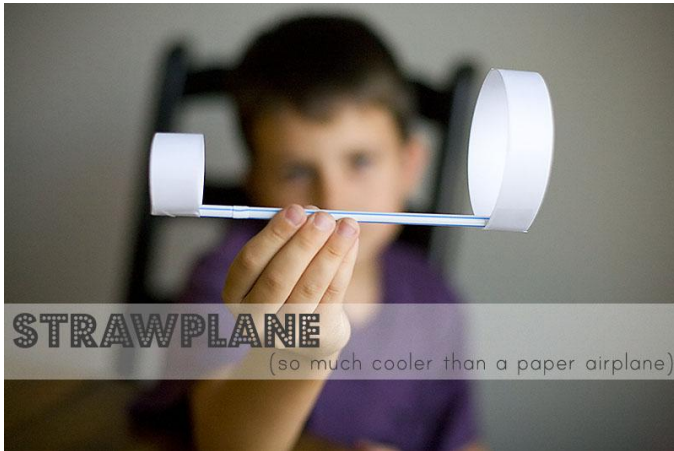

Materials:

- 3 pieces of paper about 1"x5" long, per Scout
- 1 straw per Scout
- Scotch tape
- Table

Tape two of the pieces together "long ways" and then tape to form a circle. We put tape on both sides to secure the circle.

Use the remaining piece to form a small circle and tape the ends together.

Now you have a large circle and a small circle.

Tape the straw to the inside of the circles placing the small circle at one end and the large circle at the other end.

Fly the plane. This plane flies really well.

Variations: Make squares or triangles instead of circles to see if they fly better/different.

Bead American Flag



Materials:

- 8-two inch safety pins (size 3)
- 9 blue pony beads
- 12 red pony beads
- 15 white pony beads
- 1- $\frac{3}{4}$ inch diameter PVC pipe cut approx $\frac{1}{2}$ inch thick, optional if you want to make it a neckerchief slide
- snack sized baggie – to presort supplies
- table
- sample projects

Presort all supplies into baggies, one per Scout.

1. Take six of the safety pins and create the following six combinations!
 - 3 pins with blue, red and white
 - 3 pins with just red and white (red on top)

Optional: to make the flag a neckerchief slide, add PVC pipe to one of the red/white pins!

When feeding the beads onto the pin, have the boys keep the same side of the pin as the top. Basically, you want to make sure that the white beads are on the side of the pin that closes.

Once they're done, have them line the rows up. Then take one of the extra safety pins and feed it through the flag pins in order.

Then take the last safety pin and feed it through the other end of the pins!

Catapult

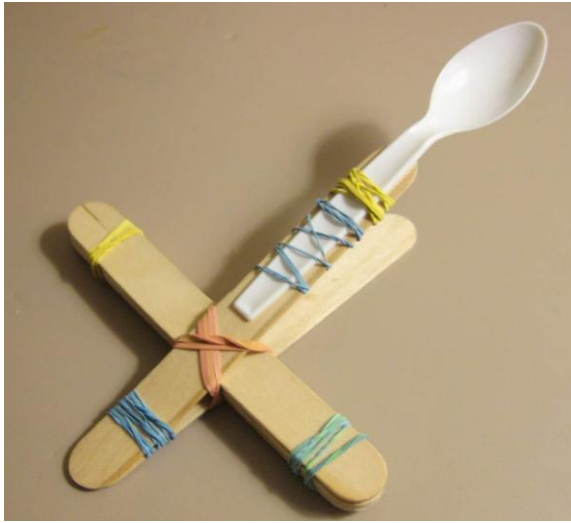

Materials:

- 9 craft sticks. Popsicle sticks may work, but wider sticks are much better.
- 4-6 rubber bands
- 1 plastic spoon
- table

1. Take 7 of the craft sticks and tie a rubber band tightly around both ends.
2. Take the remaining 2 sticks and tie a rubber band on one of the ends. Try to tie the band close to the edge of the sticks.



3. Insert the 7 sticks banded together through the 2 stick bundle.
4. Tie a rubber band in a cross fashion joining the two pieces. The closer the 7 stick bundle gets to the edge, the more leverage the catapult will have.
5. Use a few rubber bands and attach the plastic spoon on the end.

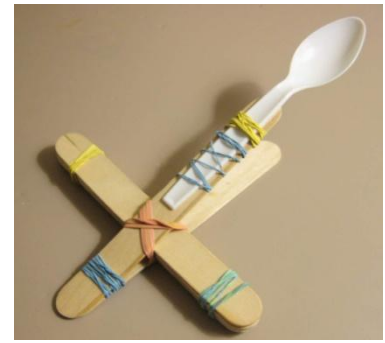

Bobcat: Scout Law and Oath Game



Materials:

- 12 craft sticks or tongue depressors per set, with one point of the Scout Law written on each stick

1. Write one point of the Scout Law or one phrase of the Scout Oath on each stick
2. Mix up the sticks and throw them on a table.
3. Have the Scouts put the set together in the correct order.

For a fun variation, make several sets and mix them together. Have teams race against each other to see who can get all twelve points of the Scout Law in the correct order first.

For a more challenging variation (e.g., for a second or third den meeting), throw in some words which are not part of the Scout Law – happy, grateful, punctual, organized)

Variation



Materials:

- Each point of the Scout Law written on pieces of poster board (or cardboard or corrugated cardboard)

Another variation

- Parts of the Scout Oath written on pieces of poster board (or cardboard or corrugated cardboard)

Copy of Scout Law and Scout Oath for the volunteer to use as a guide (see appendix)

Jumble up the words or phrases, and have the boys put them back in order.

Bobcat: Scout Law Craft



Materials:

- 16 craft sticks per Scout
- Yarn or string (~6" per Scout), pre-cut
- markers
- glue
- paper plates (to put glue on so they don't use too much glue)
- small painting brushes
- poster of the Scout Law (or several copies on each table –see appendix)
- sample craft
- paper towels / wet wipes
- paper to cover tables

1. Give each Scout 13 craft sticks (12 points of Scout Law, plus “A Scout is ...” on the top stick)
2. Have them write one point of the Scout Law on each stick.
3. Give them 3 additional craft sticks and have them glue the Scout Law sticks on top.
4. Have them use small paint brushes and brush the glue off the paper plate and paint the 3 craft sticks and then put the 13 craft sticks on top. Optional, glue on string or yarn as a hold.
5. Have the Scouts write their name and pack number on the back.

Finish



<p>ON MY HONOR I will do my best to do my duty to God and my country and to obey the Scout Law; to help other people at all times; to keep myself physically strong, mentally awake, and morally straight.</p>	<p>SCOUT OATH</p>	<p>a Scout is... loyal, helpful, friendly, kind, obedient, cheerful, brave, clean, and honorable.</p>	<p>SCOUT LAW</p>	<p>do GOOD as turn Daily</p>	<p>SCOUT SLOGAN</p>	<p>As an American, I will do my best to- be clean in my outdoor habits; be careful with fire be considerate to the outdoors. AND BE CONSERVATION- Minded.</p>	<p>OUTDOOR CARE</p>	<p>Do your best</p>	<p>OUR SCOUT MOTTO</p>	<p>I promise to apply life's LEAVE NO TRACE environmental principles wherever I go:</p> <ol style="list-style-type: none"> 1- know before you go 2- leave the right path 3- pack your trash 4- leave what you find 5- be careful with fire 6- respect wildlife 7- be kind to other visitors <p>OUTDOOR ETHICS</p>	<p>LEAVE NO TRACE</p>
---	--------------------------	---	-------------------------	---	----------------------------	--	----------------------------	------------------------------------	-------------------------------	--	------------------------------

Bobcat: “Cootie Catcher or Fortune Teller”



Materials:

- Copy of the activity for each Scout, see appendix
- Kid friendly scissors
- Samples

Bobcat Book



Materials:

- Copy for each Scout, see appendix
- Kid friendly scissors
- Samples

1. Cut out the border (outside lines)
2. Fold along all lines
3. Fold in half (top to bottom)
4. Cut dotted line



5. Open out push center cut apart in diamond, and refold the other way and form into a book.

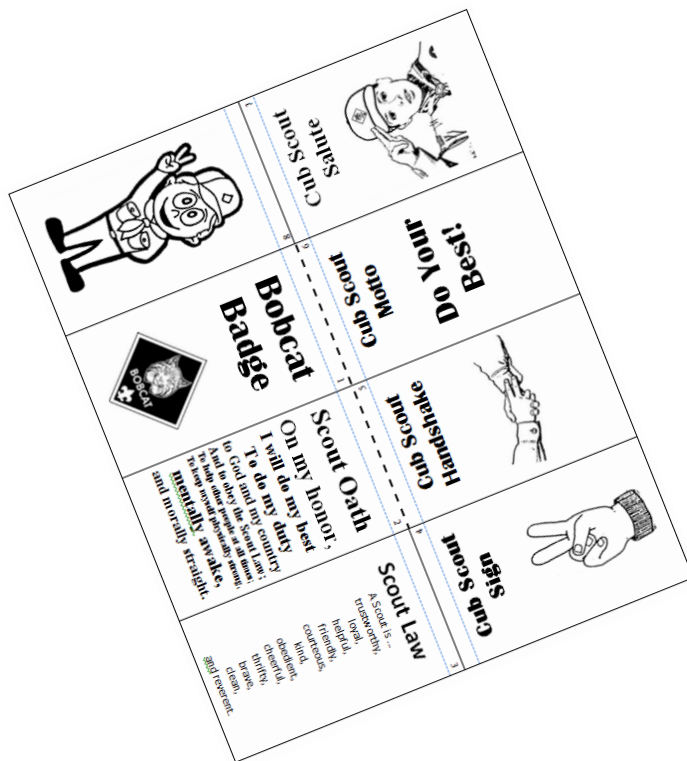

Bobcat: Wheel

Scout Law, Oath, Slogan, Motto, Outdoor Code

Need to finish and change to Cub Scouts

www.boyscouttrail.com/extras/scoutmemorize.pdf

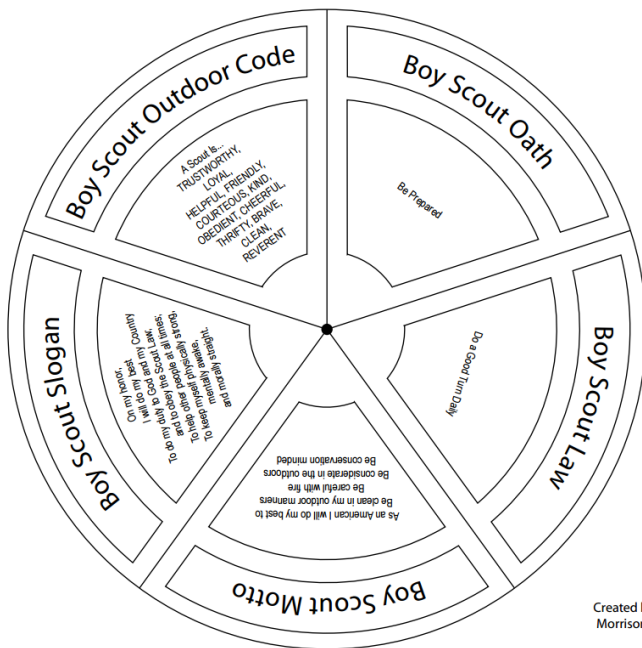

Created by
Morrison, I

Materials:

- Copies of the wheel on cardstock for each Scout
- Brad, one per Scout
- Scout friendly scissors

Directions:
Cut and fold this page:
----- Cut Line
----- Fold Line
● Paper Fastener
attach to center of
first page

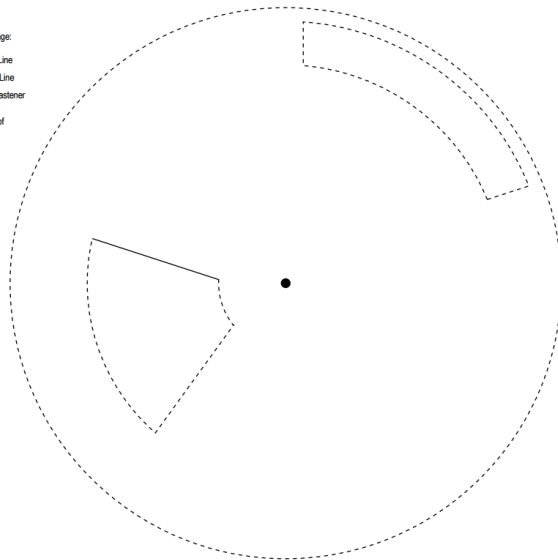

Bobcat: Relay Race Game



Materials:

- Copies of the Bobcat requirements for the volunteer (appendix)

Divide the den into two teams and have them line up at one end of the room. At the other end, station a volunteer or parent for each team. Give the volunteer or parent a copy of

Have the first boy on each team run to the parent for their team. The parent asks the boy to say or demonstrate one of the following:

1. Scout Oath
2. Scout Law
3. Cub Scout Motto
4. Cub Scout Sign
5. Cub Scout Handshake
6. Cub Scout Salute

If the boy can't answer, the parent helps.

Variation: The boys roll a dice when they get to a parent and the number on the dice corresponds to which skill he needs to demonstrate.

Variation (for returning Scouts – for a second or third den meeting): If the boy can answer the question with assistance, he runs back to tag the next boy. If he can't answer the question at all, he runs back to his team to get help then returns and answers the question.

Appendix

Cub Scout Information



WEBELOS MEANS:
"WE'LL BE LOYAL SCOUTS"

SCOUT OATH
On my honor I will do my best
To do my duty to God and my country
and to obey the Scout Law;
To help other people at all times;
To keep myself physically strong,
mentally awake, and morally straight.

SCOUT LAW
A Scout is trustworthy,
loyal, helpful, friendly,
courteous, kind, obedient,
cheerful, thrifty, brave,
clean, and reverent.

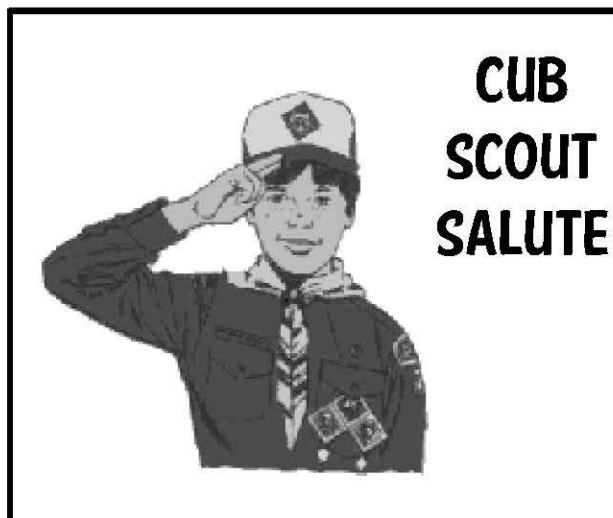

Cub Scout Information

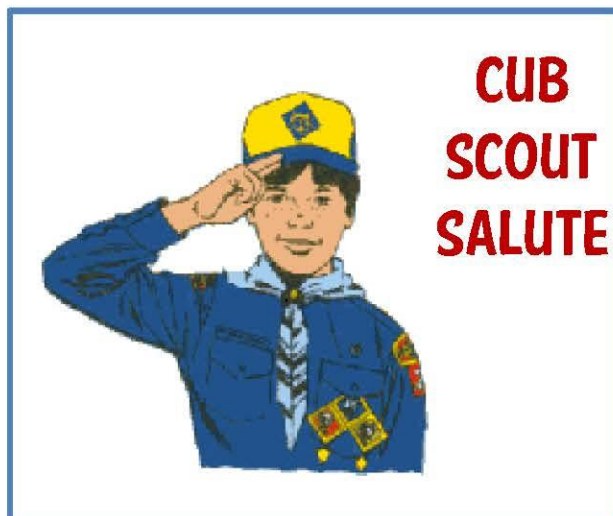
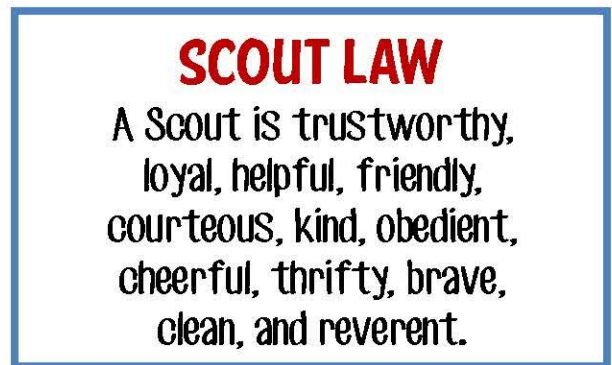
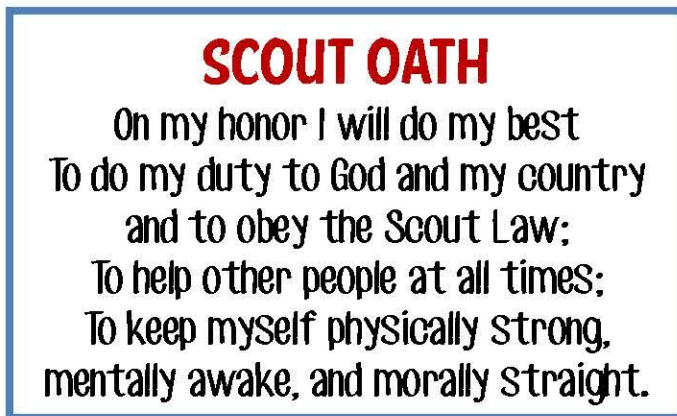
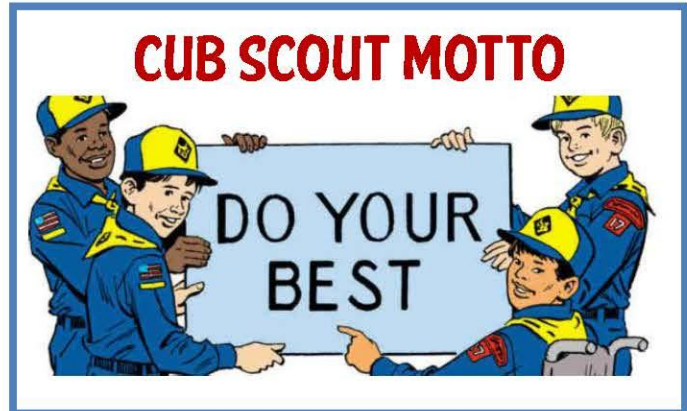

Scout Oath (or Promise)

On my honor,

I will do my best

To do my duty to God and my
country

And to obey the Scout Law;

To help other people at all times;

To keep myself physically strong,
mentally awake,

and morally straight.



Scout Law

A Scout is ...
trustworthy,
loyal,
helpful,
friendly,
courteous,
kind,
obedient,
cheerful,
thrifty,
brave,
clean,
and reverent.



Cub Scout Motto

Do Your Best!



Cub Scout Sign Meaning

The two raised fingers stand for the Scout Oath and Scout Law.

The fingers look like the ears of a wolf ready to listen to Akela.

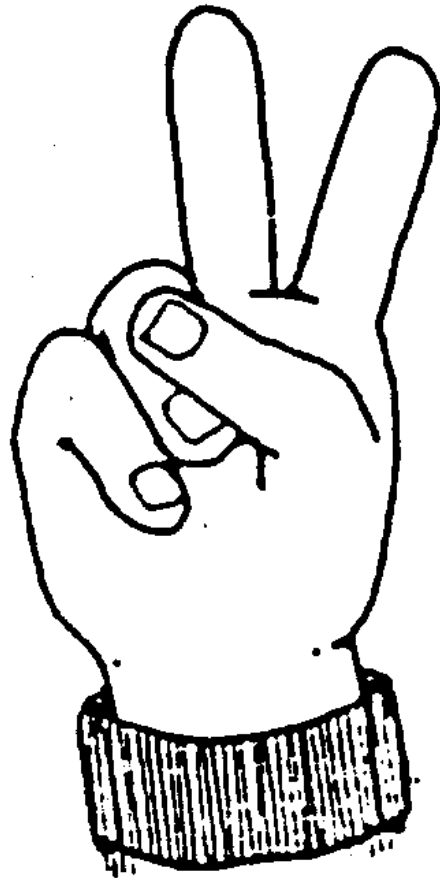

Cub Scout Handshake

Put your two fingers along the inside of the other boy's wrist.

This means you'll help each other remember the Scout Oath and Law.



Cub Scout Salute

Hold the first two fingers of your right hand close together.

Touch your fingertips to your cap.

If you aren't wearing a cap, touch your right eyebrow.





Cub Scout Salute

7

8

Do Your Best!



Cub Scout Motto

9

1

Bobcat Badge



Cub Scout Handshake

5

2

Scout Oath
On my honor,
I will do my best
To do my duty
to God and my country
And to obey the Scout Law;
To help other people at all times;
To keep myself physically strong,
mentally awake,
and morally straight.



Cub Scout Sign

4

3

Scout Law
A Scout is ...
trustworthy,
loyal,
helpful,
friendly,
courteous,
kind,
obedient,
cheerful,
thrifty,
brave,
clean,
and reverent.

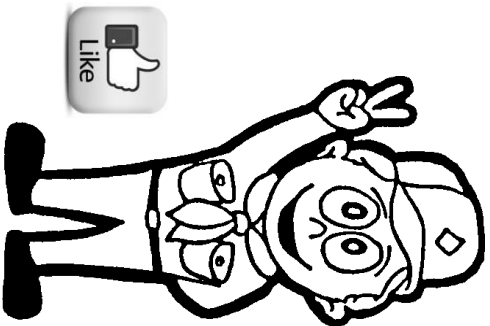

Like us on Facebook
www.facebook.com/shac.bsa



cut here

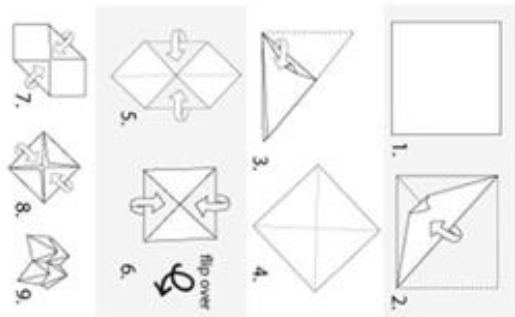

Cub Scout Motto

Do Your Best!

Sign



Salute



Scout Law

A Scout is ...
trustworthy,
loyal,
helpful,
friendly,
courteous,
kind,
obedient,
cheerful,
thrifty,
brave,
clean,
and reverent.

Handshake



Scout Oath

On my honor,
I will do my best
To do my duty to God and my country
And to obey the Scout Law;
To help other people at all times;
To keep myself physically strong,
mentally awake,
and morally straight.



cut here

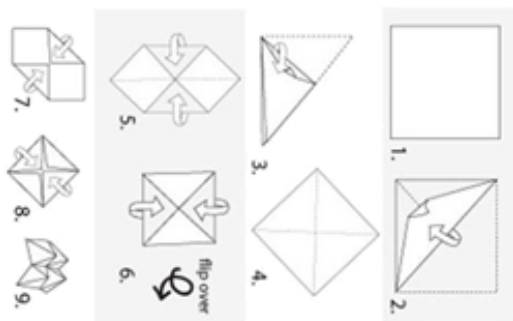

Cub Scout Motto

Do Your Best!

Sign



Salute



Scout Law

A Scout is ...
trustworthy,
loyal,
helpful,
friendly,
courteous,
kind,
obedient,
cheerful,
thrifty,
brave,
clean,
and reverent.

Handshake

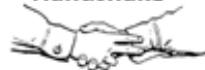

Scout Oath

On my honor,
I will do my best
To do my duty to God and my country
And to obey the Scout Law;
To help other people at all times;
To keep myself physically strong,
mentally awake,
and morally straight.